

Sea-R.O. Component Dimensions and Weight

PREFILTRATION

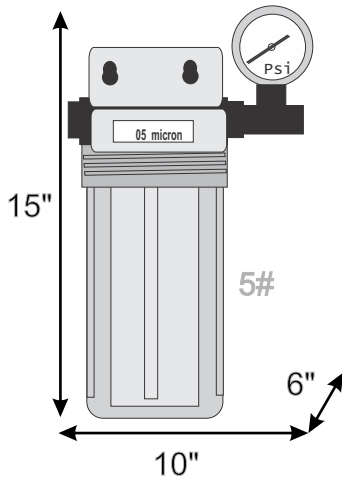

FRESH WATER FLUSH

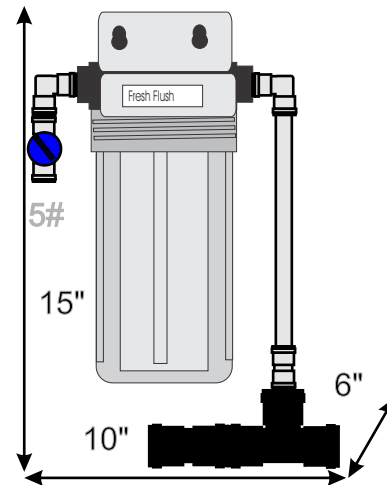

CONTROL PANEL

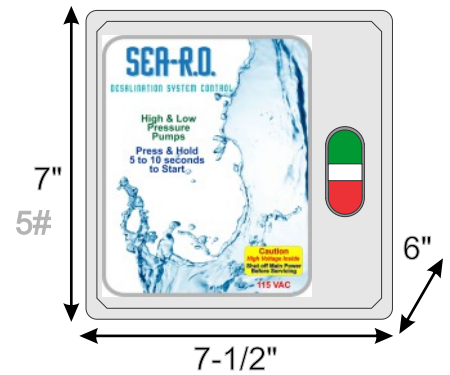

PRESSURE VESSEL ARRAY

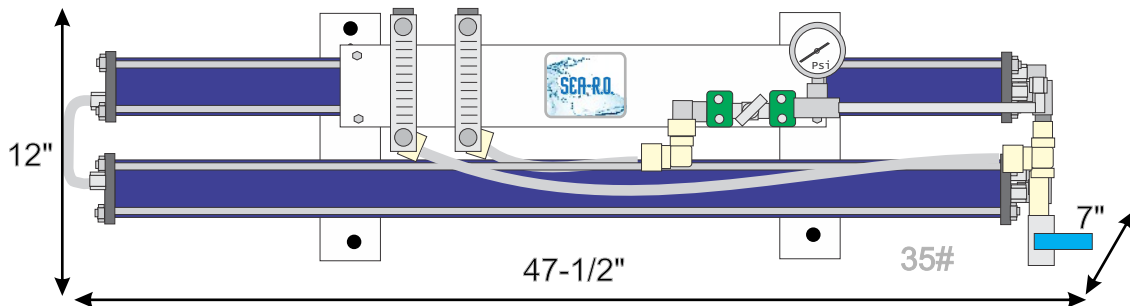

FEED PUMP

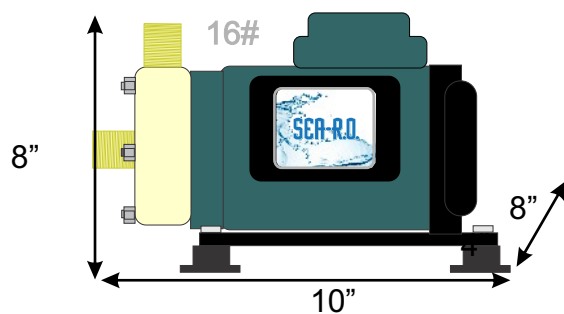

HIGH PRESSURE PUMP

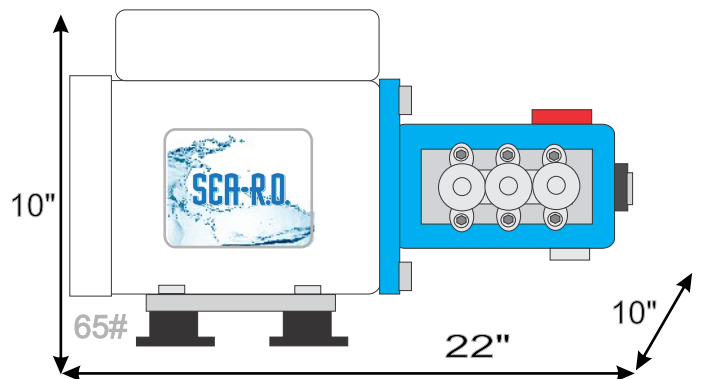

Naked Nautilus NN800 Watermaker