

Sea-R.O. Component Dimensions and Weight

PREFILTRATION

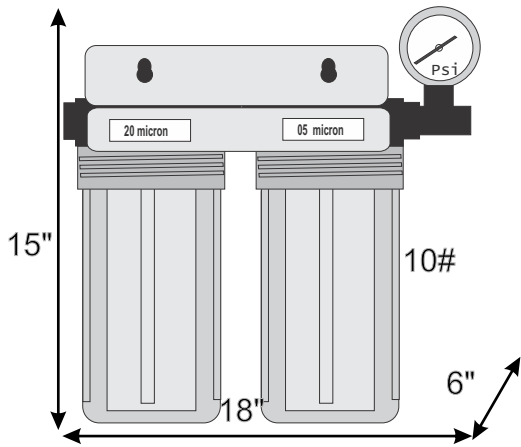

FRESH WATER FLUSH

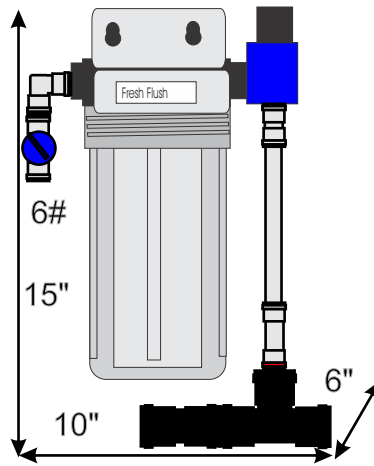

CONTROL PANEL

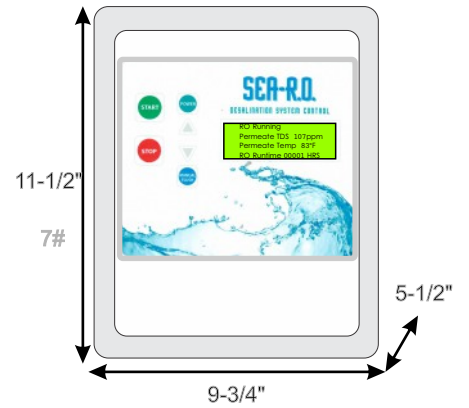

PRESSURE VESSEL ARRAY

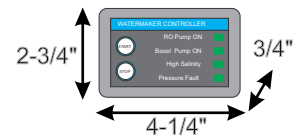
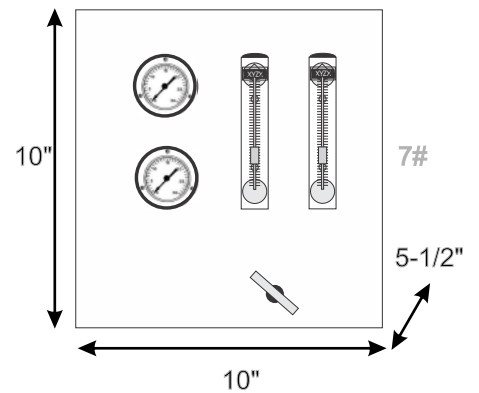
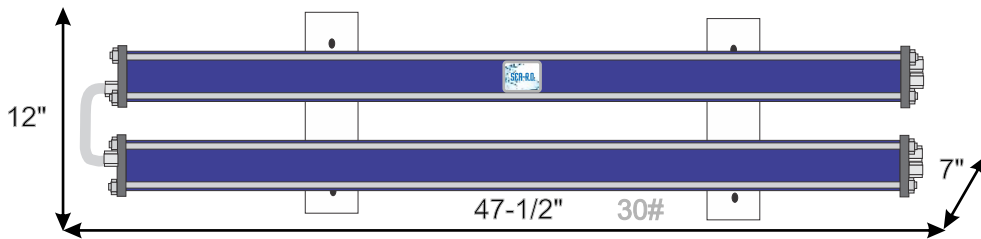

Remote Control

FEED PUMP

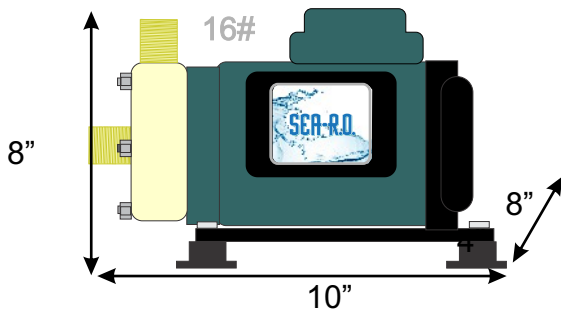

HIGH PRESSURE PUMP

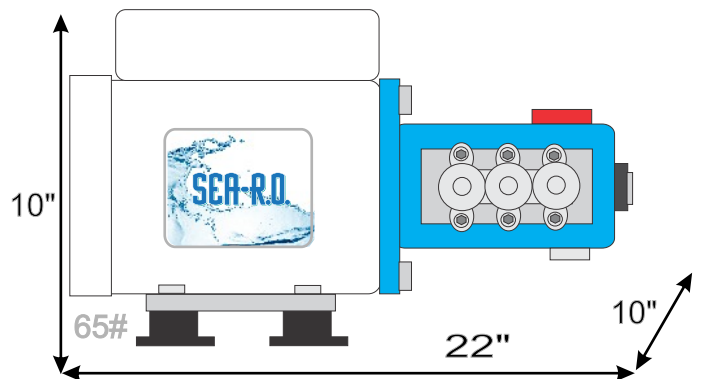

Sea Horse SH1200 Watermaker