



Sea-R.O.
WATERMAKERS

MAKING WATER BETTER, MAKING BETTER WATER

SEA-R.O., WATERMAKERS TEL: 954-527-5282 FAX: 954-462-7183

www.makeh2o.com

Sea Horse 500-1200 Gallon Per Day Modular Desalination System with I-Control and remote display/controller

Full featured system features I-Control system controller and remote control to make system operation as simple and automatic as possible. Controller provides constant reading of water quality, temperature and hourmeter. Automatic fresh water flush is activated at end of every running cycle to maintain best possible membrane performance and extend the life of membranes and all system components. Recurring flush every 7 days for 5 minutes.

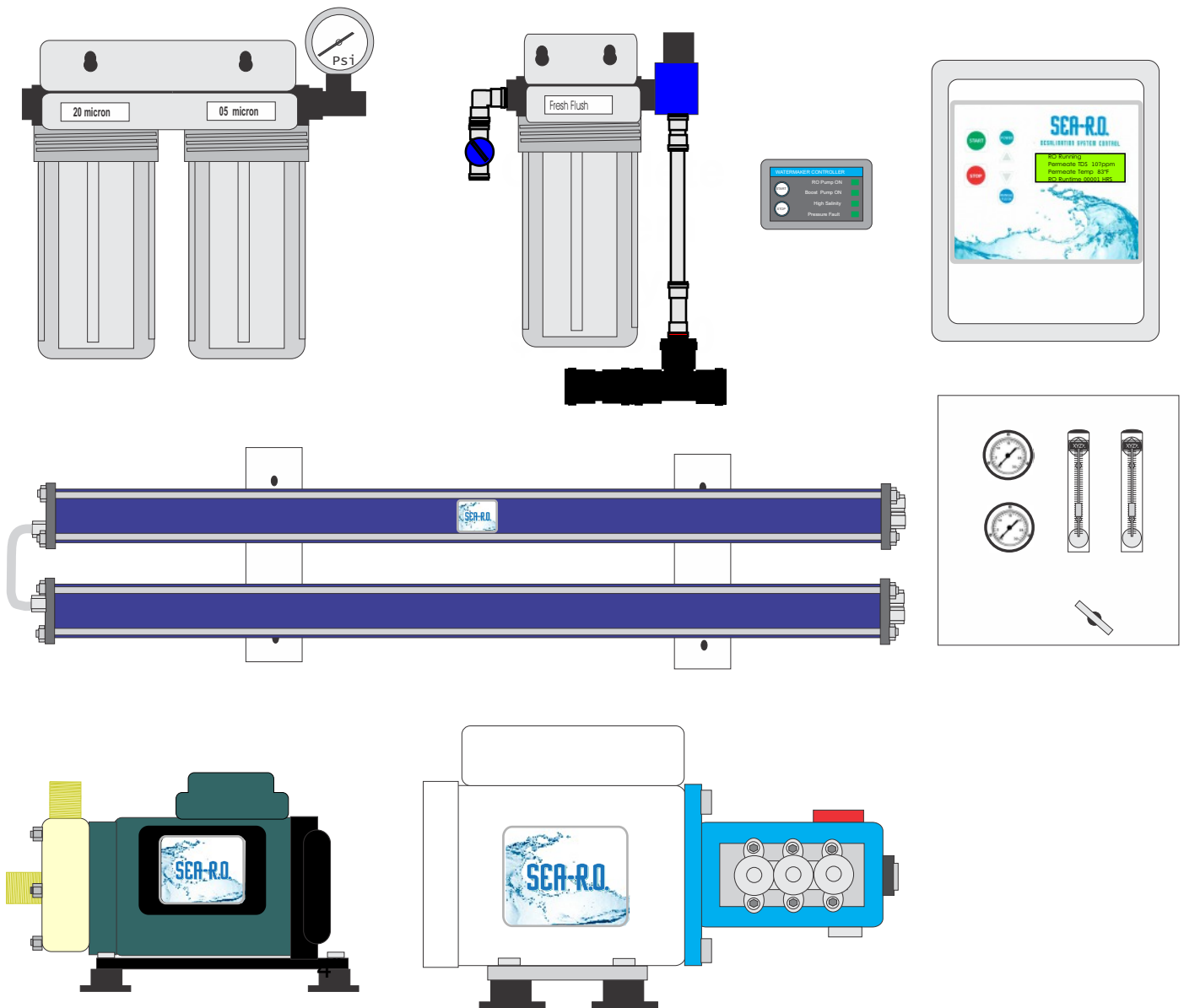



“Sea Horse” Series Membrane And Pressure Vessel Assembly

Pressure vessel is all fiberglass construction, 1000 psi rated. Simplified end cap design is rugged and easy to service with no special tools required, pressure and product ports are 316 SS with o-ring seals that allow fittings to swivel and eliminate stress on end cap material. Industry standard membrane size is available worldwide.

Mounting brackets are predrilled and allow easy attachment to bulkhead or wall, overhead mounting is possible with additional “L” brackets

High pressure piping is 316 SS with positive sealing nut and ferrule connections.

Low pressure piping is flexible poly tubing with John Guest connections for leak free operation.

Simple Product Water Sample valve is included to allow easy sampling of product water before sending to storage tank. This also is a handy method of filling a container for supply of chilled drinking water in your refrigerator that is directly from the membrane.

High pressure hose connects to pump with industry standard 316 SS flare fittings with crimp type ends. Unit comes with 2 each high pressure hoses, 1 each 6' and 1 each 10'. Custom and longer lengths are available and can be specified when ordered.

Dual prefiltration system

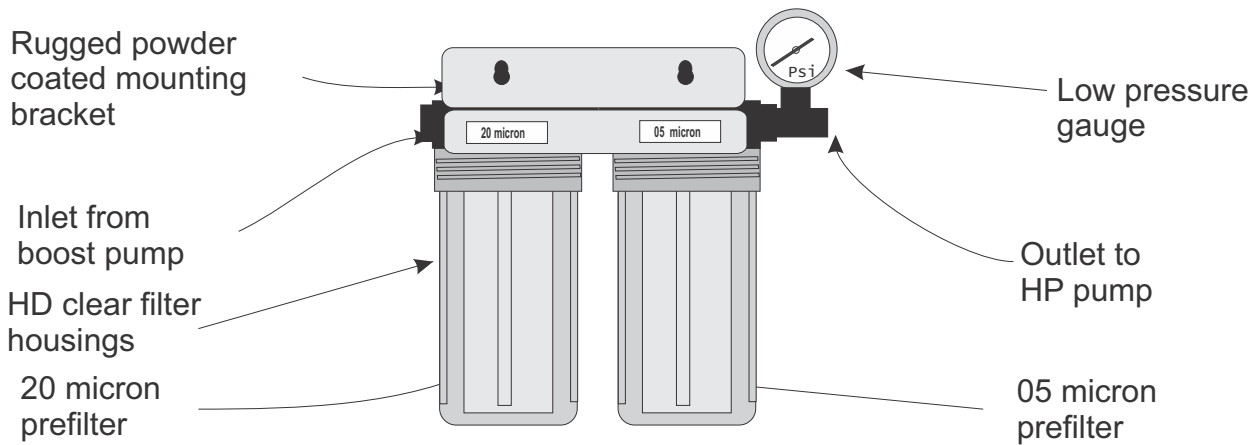

5" x 10" FDA approved polypropylene housings are heavy duty industrial rated at 125 psi. O-ring sealed to provide leak free operation. Standard 3/4" FNPT inlet and outlet.

Heavy Duty mounting bracket allows easy mounting. Filter wrench included

Low pressure gauge monitors filter performance and indicates when service is required. 316SS and glycerine filled.

Dual 20 and 05 micron filter cartridges provide optimum sediment and particle removal. 100% poly media permits cleaning several times before replacement. Industry standard 3x10" size.

Auto Fresh water flush system

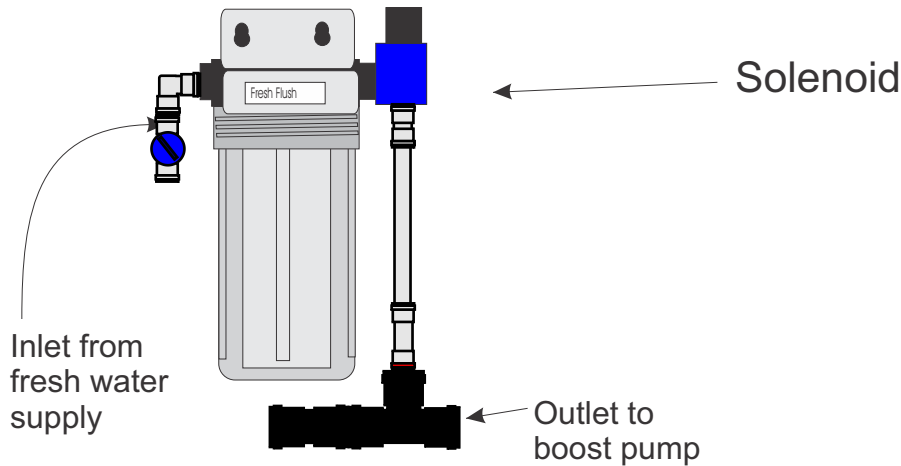

Auto Flush option flushes system on every shut down with de-chlorinated fresh water to purge sea water from system and greatly extend membrane performance.

Clear FDA approved polypropylene housing is heavy duty industrial rated at 125 psi. O-ring sealed to provide leak free operation, standard 3/4" FNPT inlet and outlet.

Three way valve allows simple change over from normal to flushing mode.

Solid block carbon filter removes chlorine from fresh water supply, providing flush water without any negative affect on membrane. This also allows production of ultrapure water for battery filling,

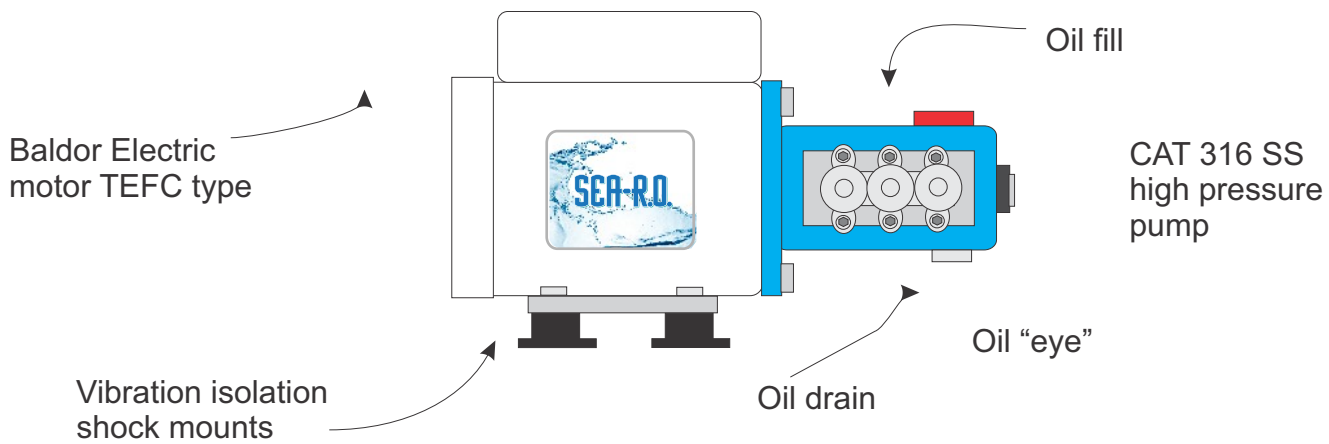

High pressure pump and motor assembly

CAT 316 SS high pressure pump is a ceramic plunger design for long life and proven performance in seawater. CAT pumps are the longest lasting, most trouble free pumps available, service and parts distribution available worldwide and the simple design allows easy routine service without any special tools.

Pump has an oil filled crankcase with easy access to drain and fill. Unique oil "eye" allows oil level to be checked with a glance. No drips or dipsticks necessary.

Industry standard Baldor motor is the best, most efficient motor available. Service is almost never required, but if so, Baldor has an outstanding worldwide network of agents and service centers.

Pump and motor are smooth and quiet by design, and yet we go one step to further dampen any noise and vibration with flexible mounts. These also elevate the pump and motor to allow cleaning beneath the assembly.

Control panel provides total motor and pump protection from low voltage, low or high pressure, or improper operation.

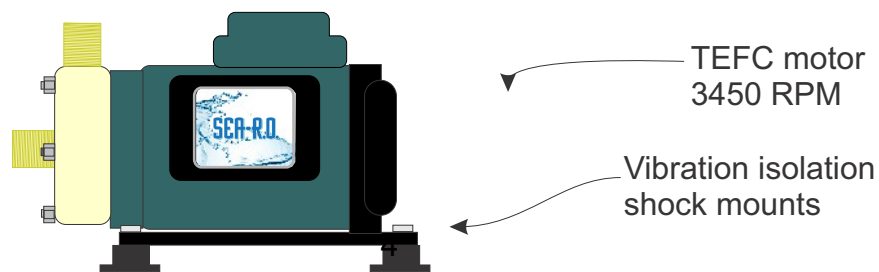

Boost pump and motor assembly

High Head Magnetic Drive poly pump close coupled to 3450 RPM motor provides 20-25 psi of boost pressure for optimum filter life.

Vibration isolation mounts to eliminate noise and elevate assembly.

Pump is protected by control panel from dry running or low voltage

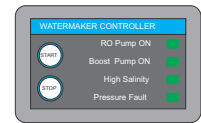
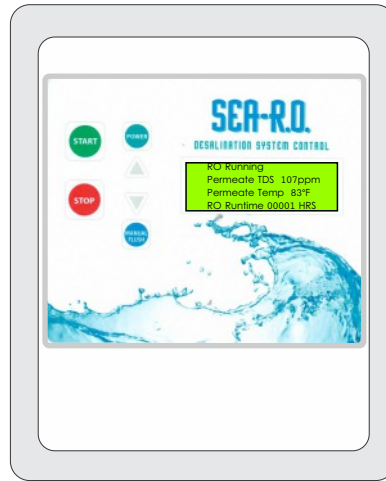
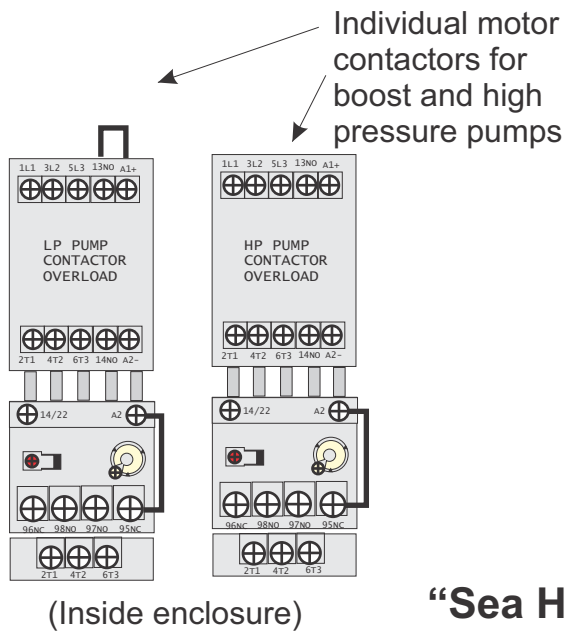

Remote Control
with 50' cable

“Sea Horse” System Control Panel with I-Control and remote control or float switch

System control panel provides complete operation and protection of all other system components. Rugged electrical components are housed inside a NEMA 4X rated enclosure which can tolerate splashing, washdowns, and the corrosive environment where watermakers are used.

Sequential starting of boost pump for 60 seconds before high pressure pump provides thorough pre-flush of system and reduces the starting amperage for optimum energy efficiency

Resettable overloads will safely shut system down if supply voltage is too low. This can occur on boat electrical systems, marinas, and islands.

Safety shut down switch for low pressure prevent any damage to components if the system is starved for water from a blocked inlet.

High pressure switch protects system from any possible operator error.

Liquid-tight flex fittings are used on power supply, high pressure pump, and boost pump umbilical cables. These fittings prevent strain and chafe on cables where they enter control panel and motors.

10 foot leads are provided as standard. Longer lengths are available for an additional charge, or may be added in the field by installer. Multi-strand, tinned copper wire in round gray protective sheath (boat cable) is standard. High pressure pump and boost pump are pre-wired.. You only need to connect the power supply.

Complete wiring diagram is provided for installation and operation.

Water Quality Monitor is factory preset to divert to drain any water that is produced that is over USEPA standards of 500 ppm. Display has constant read out of water quality, water temperature, and hourmeter

Remote control is easy to install with only one hole to drill and is surface mounted. Includes 50' cable with longer lengths available. Indicators for RO Pump ON, Boost Pump ON and alarms for High Salinity and Pressure Fault.