

# Sea-R.O. Component Dimensions and Weight

PREFILTRATION

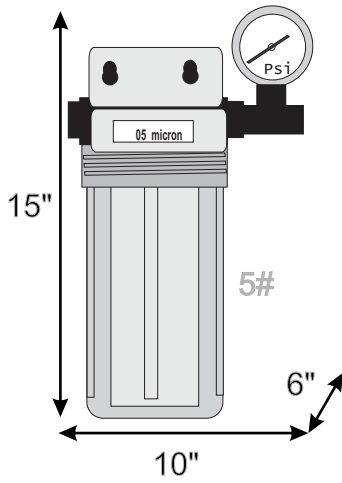

FRESH WATER FLUSH

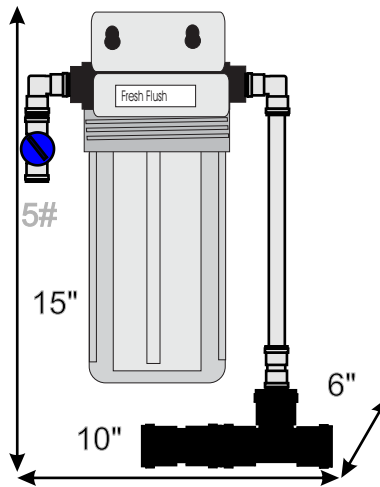

CONTROL PANEL

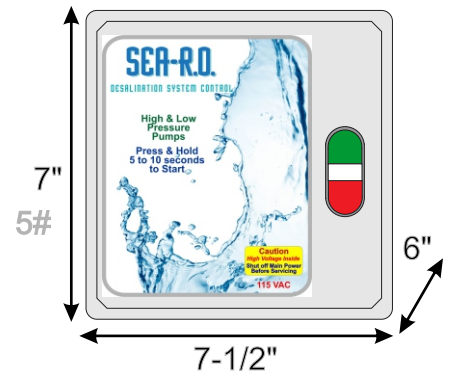

PRESSURE VESSEL ARRAY

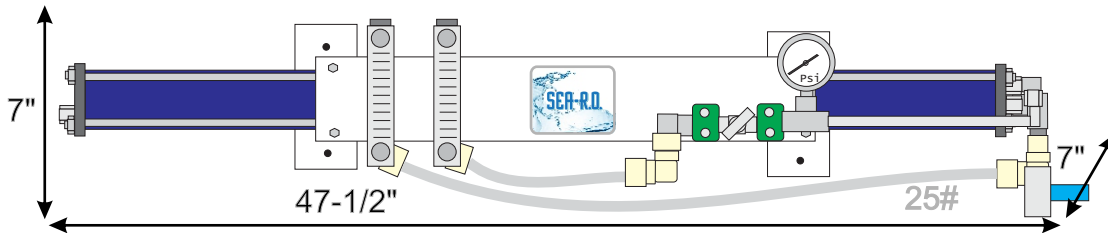

FEED PUMP

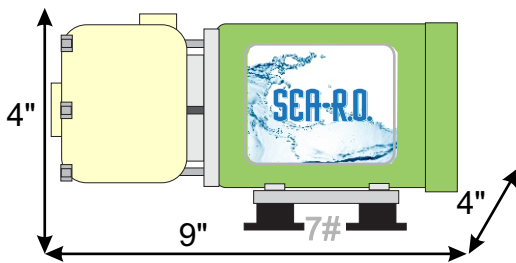

HIGH PRESSURE PUMP

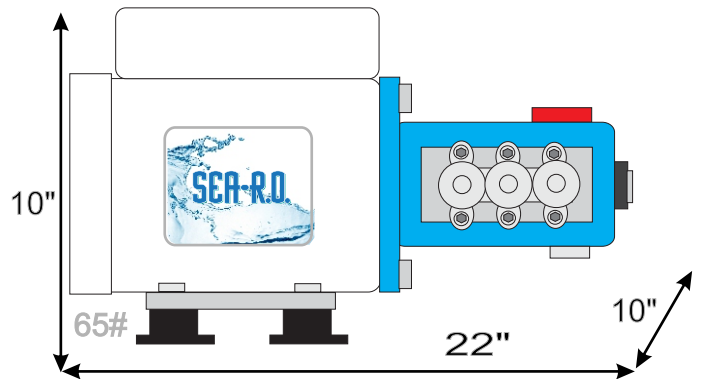

## Naked Nautilus NN500 Watermaker